

SMART OUTLET PLUG QUICK INSTALL GUIDE

A3 Smart Home

STEP 1 LOCATE OUTLET NEAR PANEL

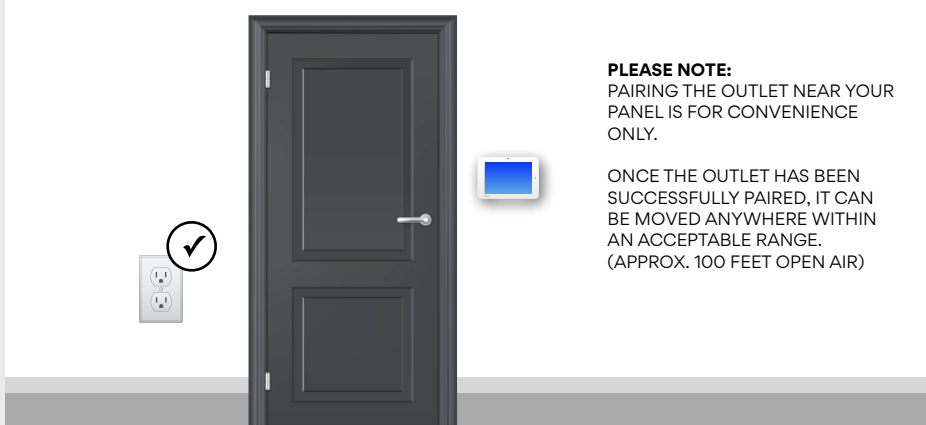

STEP 2 PLUG INTO OUTLET

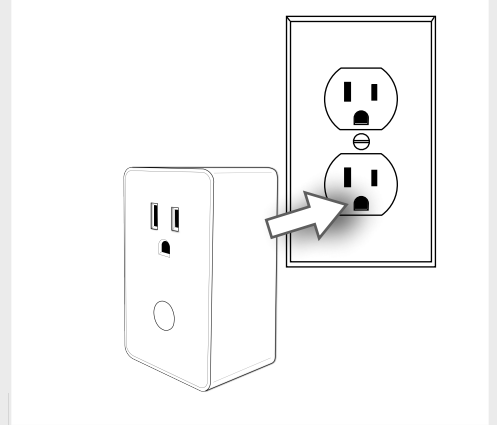

STEP 3 PAIR WITH PANEL



Place your panel in "autolearn" mode

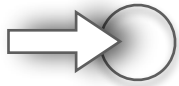

Plug in and press the button to "tamper" the device

ADD

Customize name and settings as desired and touch "ADD"

STEP 4 DECIDE WHAT TO CONTROL

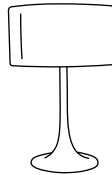

LAMPS

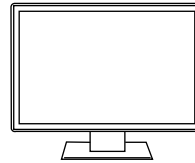

ELECTRONICS



APPLIANCES

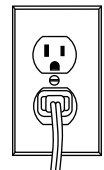

ANYTHING

STEP 5 LOCATE DESIRED OUTLET

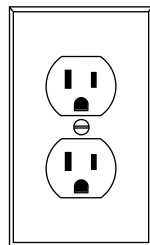

STEP 6 PLUG IN SMART SOCKET

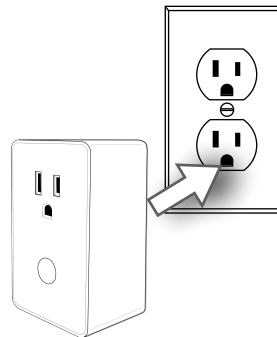

STEP 7 PLUG DEVICE IN

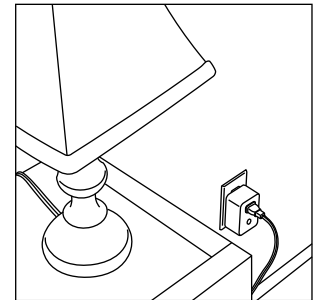

Max current 15A or 1800W

Installation Support:
(877) 998-1457
a3smarthome.com/install